

# Helixon



①



②









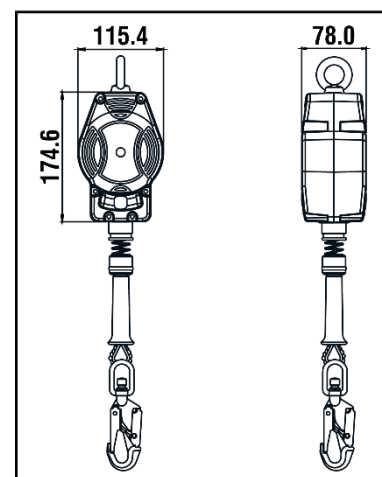

③



II2 G Exh IIC T6 Gb



<b>HS CODE</b>
84798997
<b>CARTON SIZE / PCS.</b>
60 x 40 x 24 cm / 7
<b>AET N°2777/10824-02/E05-01</b>
<b>Satra Technology Europe Ltd., N° 2777,</b> Bracetown Business Park, Clonee, Dublin, D15YN2P, Ireland
<b>MODULE D FI14/14003.02</b>
<b>SGS Fimko Oy, N°0598</b> Takomotie 8, 00380 HELSINKI, Finland
<b>ACKNOWLEDGEMENT OF RECEIPT N°3975/1/2018 (ATEX)</b>
<b>Technická Inšpekcia, a.s. N°1354</b> Trnavská cesta 56, 821 01 Bratislava, Slovenská Republika

REF.	FA 20 402 03B
LG.  KG	3,50 m
CE	EN 360:2002
MAT. 	Polyamide 6 - 30% fiber glass  STEEL $\varnothing$ 4.5 mm
	 FA 50 101 17 / FA 50 203 20 with fall indicator
	x2
R(kN)	12 kN
	NO
+	ATEX Zone 1, EN 360 §4.6 (endurance test)
	1.88 KG

LG.  
 KG

**Longueur** Poids maxi utilisateur  
**Length** Max. user weight  
**Longitud** Peso máximo del usuario  
**Lunghezza** Peso Max. dell'utente  
**Länge** Höchstgewicht des Benutzers

MAT.  

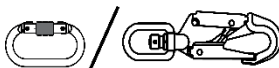

**Matière carter / câble**  
Material of casing / wire rope  
**Material cárter / cable**  
Material dei carter / cavo  
**Material Gehäuse / Seil**



**Matière connecteur haut / connecteur bas**  
Material of top connector / bottom connector  
**Material conector alto / conector bajo**  
Materiale connettore alto / connettore basso  
**Material oberes / unteres Verbindungselement**



**Nombre d'émerillons**  
Number of swivels  
**Cantidad de eslabones giratorios**  
Numero di tornichetti  
**Anzahl der Wirbel**



**Homologué pour le travail à proximité d'arêtes vives**  
Approved for work near sharp edges  
**Homologado para trabajo cerca de aristas vivas**  
Omologato per lavoro in prossimità di spigoli vivi  
**Zugelassen für Arbeiten in der Nähe scharfer Kanten**